

46" & 72" DINING TABLE

INSTRUCTIONS

46" Dining Table Pictured

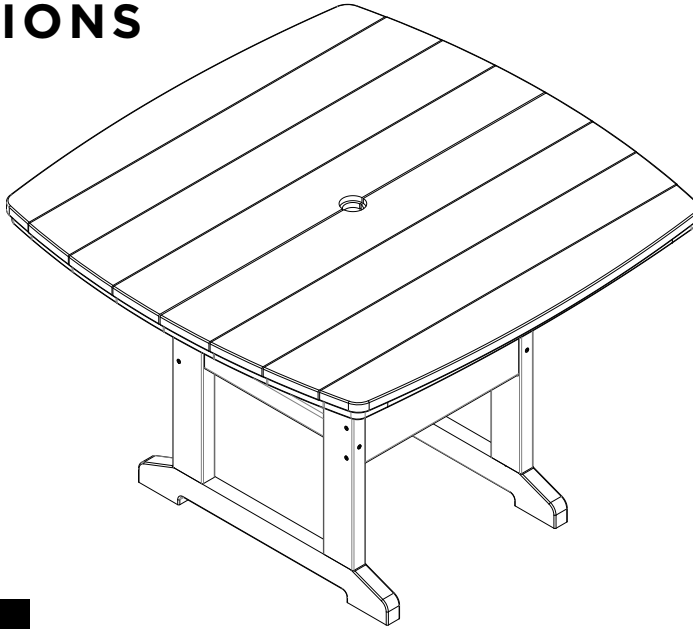

ASSEMBLY

STEP 1. Use (16) 3" screws to attach fascia plates and spreaders to leg assemblies.

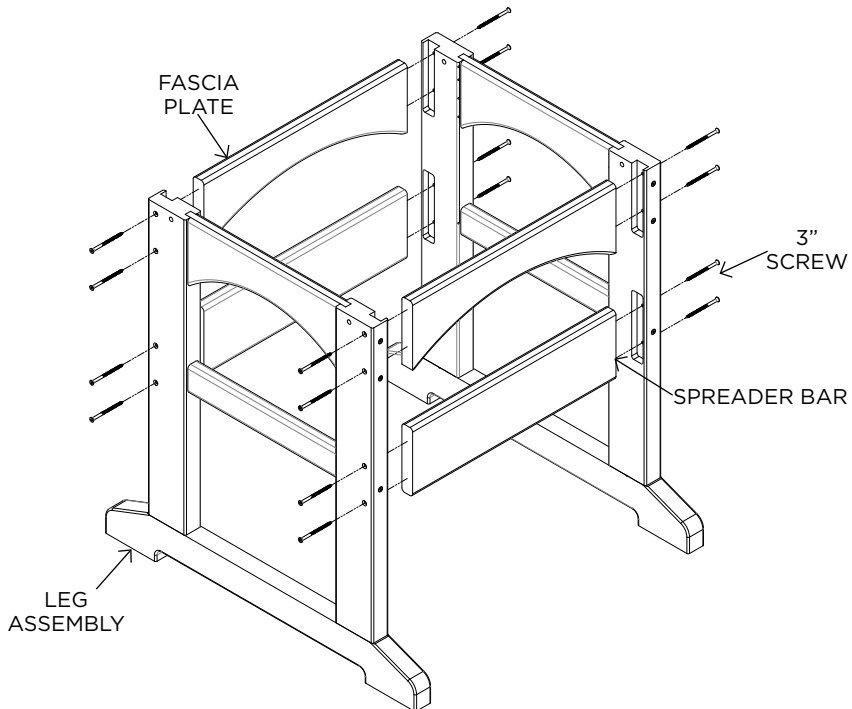

HARDWARE PACK

Hardware Pack Weight: 6.7 oz.

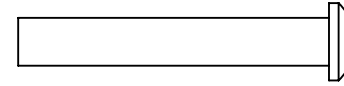

(4) 2.5" BARREL BOLTS

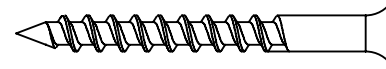

(16) 3" SCREWS

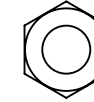

(4) LOCK NUTS

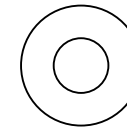

(8) WASHERS



(1) ALLEN WRENCH

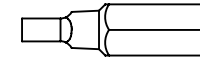

(1) SQUARE-HEAD BIT

TABLE PARTS

- (1) TABLE TOP
- (2) LEG ASSEMBLIES
- (2) FASCIA PLATES
- (2) SPREADER BARS

SUGGESTED TOOLS

- ADJUSTABLE WRENCH
- DRILL

ASSEMBLY

STEP 2. Align holes in Table Legs with holes in Table Top and use (4) 2.5" bolts, (8) washers and (4) lock nuts to attach leg structure to table top. Secure bolt by placing one washer and one nut in that order.

Tighten all bolts.

Refer to detailed image for hardware order.

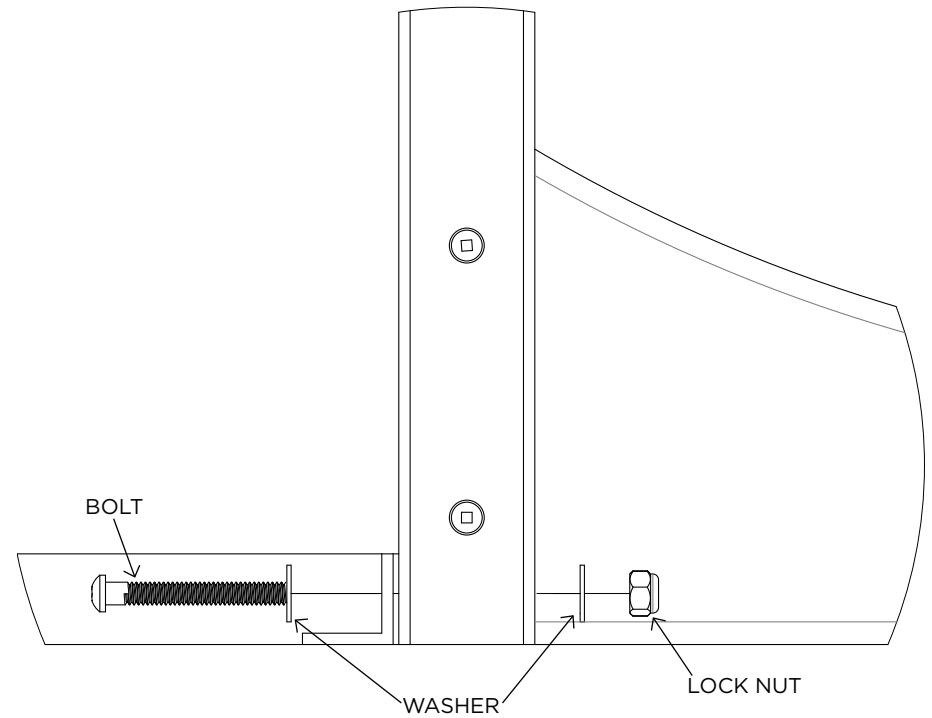
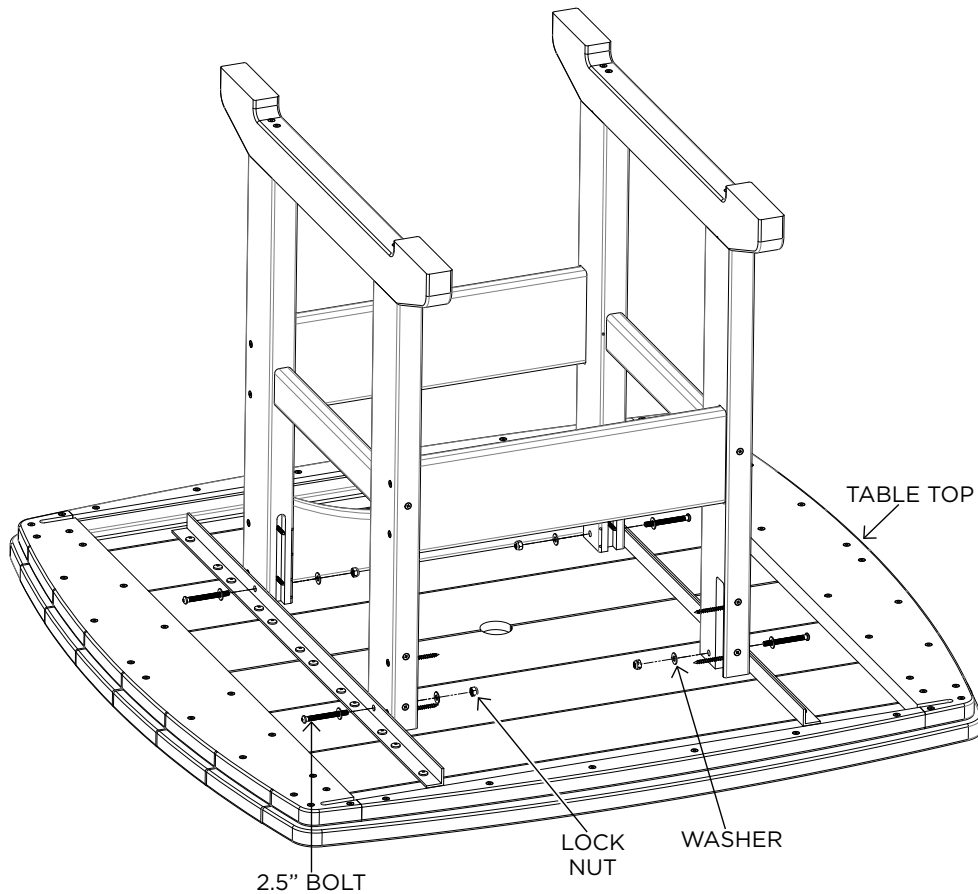

Congratulations on purchasing this Durawood 46" or 72" Dining Table. QUESTIONS REGARDING THIS PRODUCT? Call our customer service team, 252-758-0641.

RESIDENTIAL WARRANTY - This quality product includes a LIMITED LIFETIME WARRANTY for RESIDENTIAL CUSTOMERS. In the unlikely event any splintering, rotting, cracking, peeling, or chipping should ever occur, The Hammock Source will supply replacement parts or replace the furniture, at no charge to you. This does not include negligence, improper use, animal damage or damage caused by natural disasters. When using around fire, keep furniture at a minimum distance of 30 inches from the heat source. Prevent prolonged exposure to chlorinated water. Note that an original sales receipt must accompany any returned product, along with a Return Authorization Number from Hammock Source customer service; call toll-free at 252-758-0641.

CONTRACTOR WARRANTY - CONTRACTORS receive a LIMITED 7-YEAR WARRANTY. Follow the same steps outlined above.

MAINTENANCE - Thoroughly inspect product before each use. Periodically check bolts after assembly and re-tighten when necessary.

